

SCALE 1:1

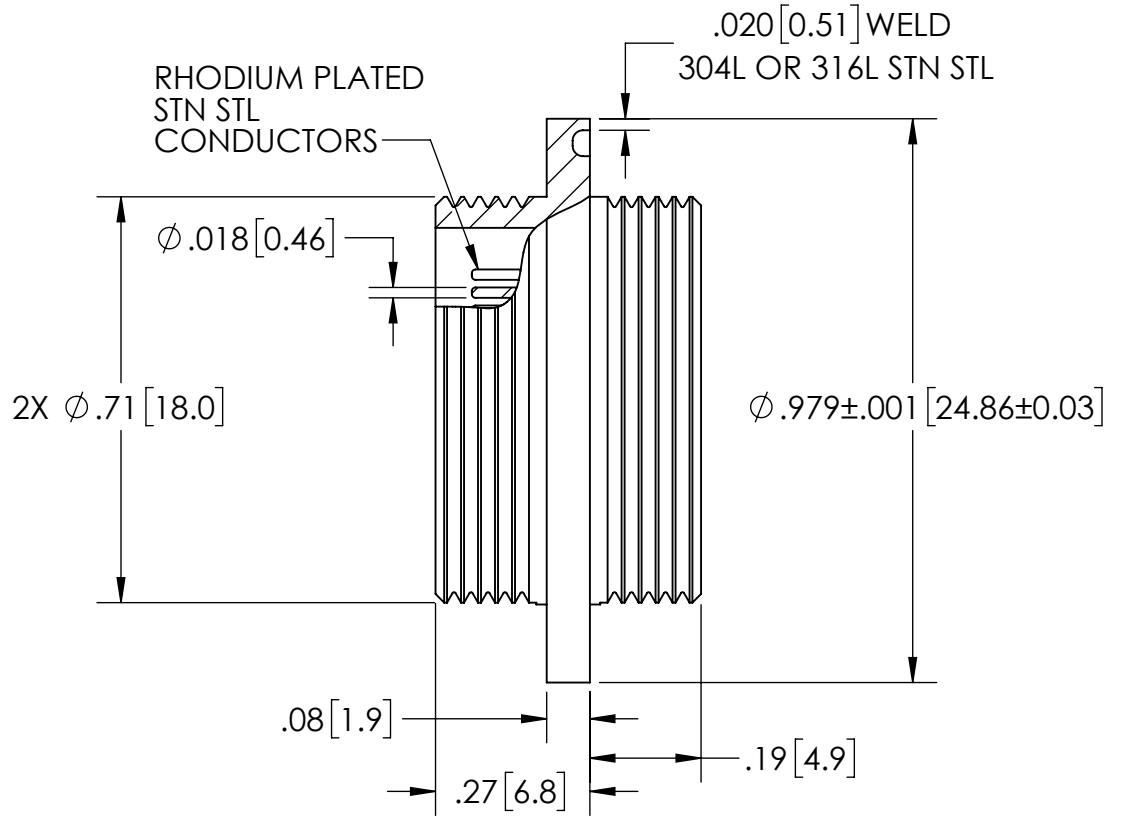

PLUGS & CONTACTS SOLD SEPARATELY

- AIR / VACUUM SIDE PLUG (WITHOUT CONTACTS): FA42256
- GOLD PLATED BRASS/BeCu CRIMP CONTACTS: KT41236
- GOLD PLATED TeCu/BeNi CRIMP CONTACTS: KT41236-02

PERFORMANCE SPECIFICATIONS	
VOLTAGE (DWV):	250V DC
CURRENT	2.3 AMPS*
TEMPERATURE:	-269°C TO 450°C

*CURRENT FOR A SINGLE PIN (60°C HEAT RISE). DE-RATING MAY BE REQUIRED WHEN RUNNING MULTIPLE CONTACTS AT FULL CURRENT.

WELDING INSTRUCTIONS AVAILABLE AT SOLIDSEALING.COM UNDER THE RESOURCES TAB
LEAK RATE < 1 X 10E-10 ATM-CC/SEC (He)

PROPRIETARY AND CONFIDENTIAL THE INFORMATION CONTAINED IN THIS DRAWING IS THE SOLE PROPERTY OF SOLID SEALING TECHNOLOGY. ANY REPRODUCTION IN PART OR AS A WHOLE WITHOUT THE WRITTEN PERMISSION OF SOLID SEALING TECHNOLOGY IS PROHIBITED.				THIRD ANGLE PROJECTION 		TITLE MICRO C, 55 PIN, RHODIUM PLATED			
REV.	APP'D	DATE	SCALE 3:1	DIMENSIONS IN INCHES [mm]	DRAWN	JF	3/26/2021	PART NO. FA42250 REV. A WWW.SOLIDSEALING.COM	
A4	CW	8/8/2023	MPCL0703-55		ENG APPR.	JF	3/26/2021		

DIMENSIONS ARE FOR REFERENCE ONLY. UNLESS NOTED, NO TOLERANCES ARE IMPLIED. CONSULT SST TO DISCUSS YOUR SPECIFIC REQUIREMENTS.

3 PINS

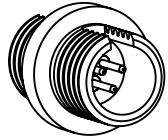

HERMETIC FEEDTHRU
FA42916
(LASER WELD ONLY)

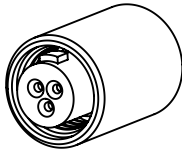

PLUG
FA42930*

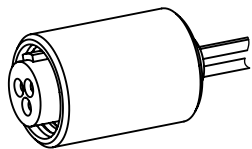

PRE-WIRED PLUG
-KAPTON: FA43039
-PTFE: FA43040

7 PINS

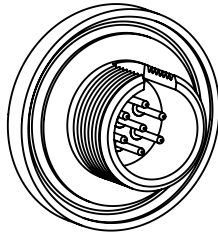

HERMETIC FEEDTHRU
FA41283

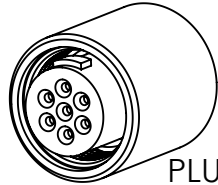

PLUG
FA41289*

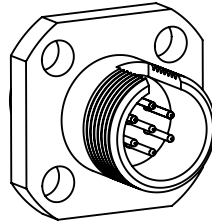

IN-VAC RECEPTACLE
FA42367

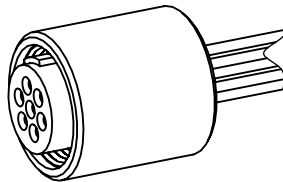

PRE-WIRED PLUG
-KAPTON: FA42314
-PTFE: FA42315

19 PINS

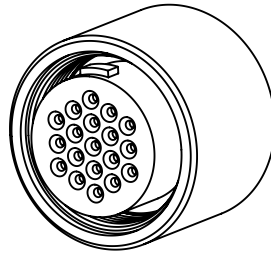

PLUG
FA41232*

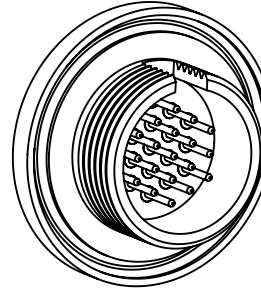

HERMETIC FEEDTHRU
FA41401

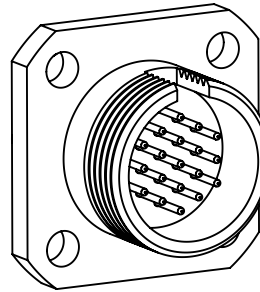

IN-VAC RECEPTACLE
FA41656

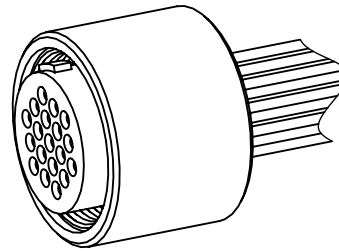

PRE-WIRED PLUG
-KAPTON: FA42316
-PTFE: FA42317

55 PINS

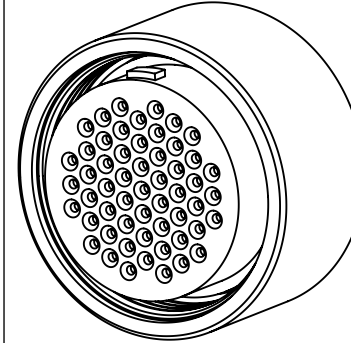

PLUG
FA42256*

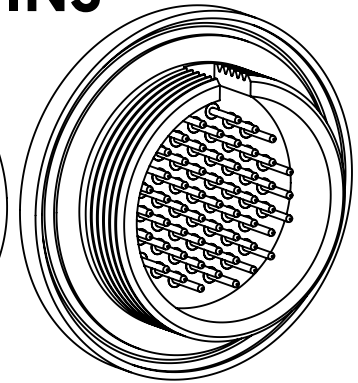

HERMETIC FEEDTHRU
FA42250

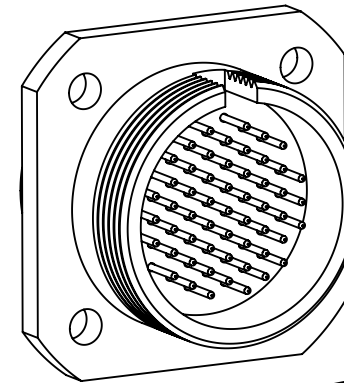

IN-VAC RECEPTACLE
FA42375

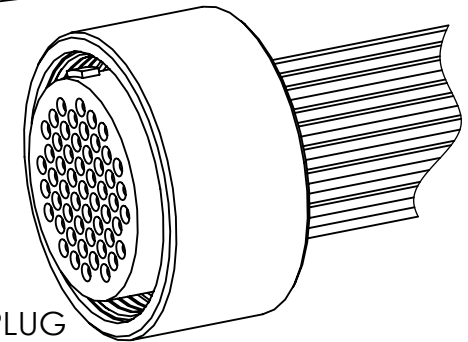

PRE-WIRED PLUG
-KAPTON: FA42318
-PTFE: FA42319

***CONTACTS NOT INCLUDED**

PROPRIETARY AND CONFIDENTIAL

THE INFORMATION CONTAINED IN THIS DRAWING IS THE SOLE PROPERTY OF SOLID SEALING TECHNOLOGY. ANY REPRODUCTION IN PART OR AS A WHOLE WITHOUT THE WRITTEN PERMISSION OF SOLID SEALING TECHNOLOGY IS PROHIBITED.

THIRD ANGLE PROJECTION

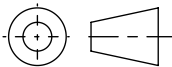

TITLE

MICRO SERIES FAMILY



SOLID SEALING
TECHNOLOGY

REV.	APP'D	DATE	SCALE 2:1	DIMENSIONS IN INCHES [mm]	DRAWN	HJ	04/09/2021
A2	CW	4/21/2022	MPC10735-11		ENG APPR.	HJ	05/03/2021

REV: A2

WWW.SOLIDSEALING.COM

SALES DWG NO. MICRO_SERIES REV. A2

DIMENSIONS ARE FOR REFERENCE ONLY. UNLESS NOTED, NO TOLERANCES ARE IMPLIED. CONSULT SST TO DISCUSS YOUR SPECIFIC REQUIREMENTS.

9 PINS

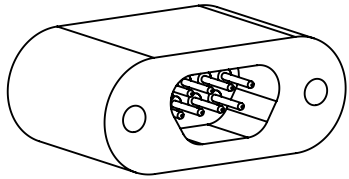

HERMETIC FEEDTHROUGH FA41500

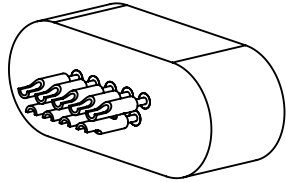

HERMETIC SOLDERCUP FEEDTHROUGH FA42164

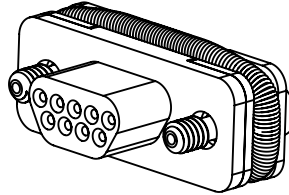

PLUG, GARTER TYPE FA42137

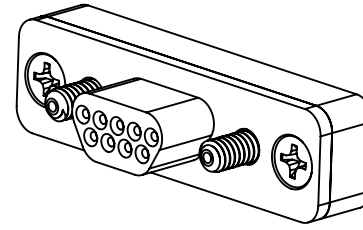

PLUG, SCREW TYPE: FA41506
PRE-WIRED PLUG
-KAPTON: FA42239
-PTFE: FA42419

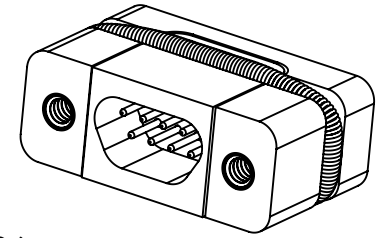

IN-VAC RECEPTACLE FA42394

15 PINS

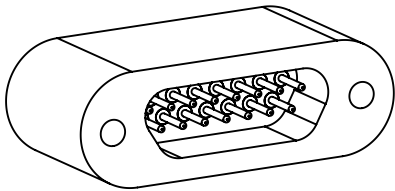

HERMETIC FEEDTHROUGH FA42273

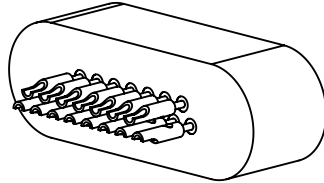

HERMETIC SOLDERCUP FEEDTHROUGH FA42467

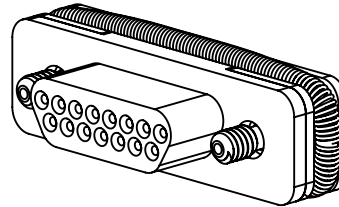

PLUG, GARTER TYPE FA42475

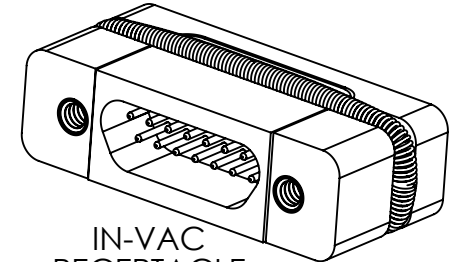

IN-VAC RECEPTACLE FA42488

CONTACTS/WIRE

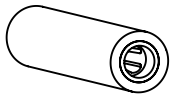

SOCKET CONTACTS
KT41236 (BRASS 125C)
KT41236-02 (TeCu 250C)

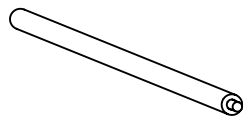

WIRE
KAPTON 48": FA42244
KAPTON 96": FA42245
PTFE 48": FA42246-01/09
PTFE 96": FA42247-01/09



CRIMP TOOL POSITIONER (PIN & SOCKET) FP41731

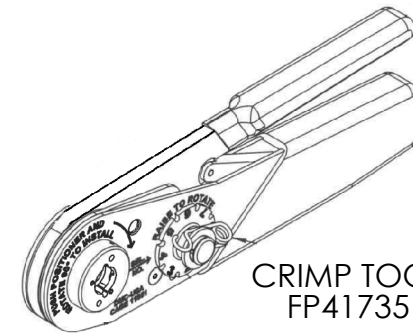

CRIMP TOOL FP41735

PROPRIETARY AND CONFIDENTIAL

THE INFORMATION CONTAINED IN THIS DRAWING IS THE SOLE PROPERTY OF SOLID SEALING TECHNOLOGY. ANY REPRODUCTION IN PART OR AS A WHOLE WITHOUT THE WRITTEN PERMISSION OF SOLID SEALING TECHNOLOGY IS PROHIBITED.

THIRD ANGLE PROJECTION

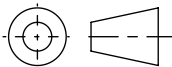

TITLE

MICRO SERIES FAMILY



SOLID SEALING
TECHNOLOGY

REV.	APP'D	DATE	SCALE 2:1	DIMENSIONS IN INCHES [mm]	DRAWN	HJ	04/09/2021
A2	CW	4/21/2022	AHDWR027-41		ENG APPR.	HJ	05/03/2021

REV. A2

WWW.SOLIDSEALING.COM

SALES DWG NO. MICRO_SERIES REV. A2

DIMENSIONS ARE FOR REFERENCE ONLY. UNLESS NOTED, NO TOLERANCES ARE IMPLIED. CONSULT SST TO DISCUSS YOUR SPECIFIC REQUIREMENTS.