

FOR LASER WELD INSTALLATION ONLY.

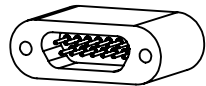
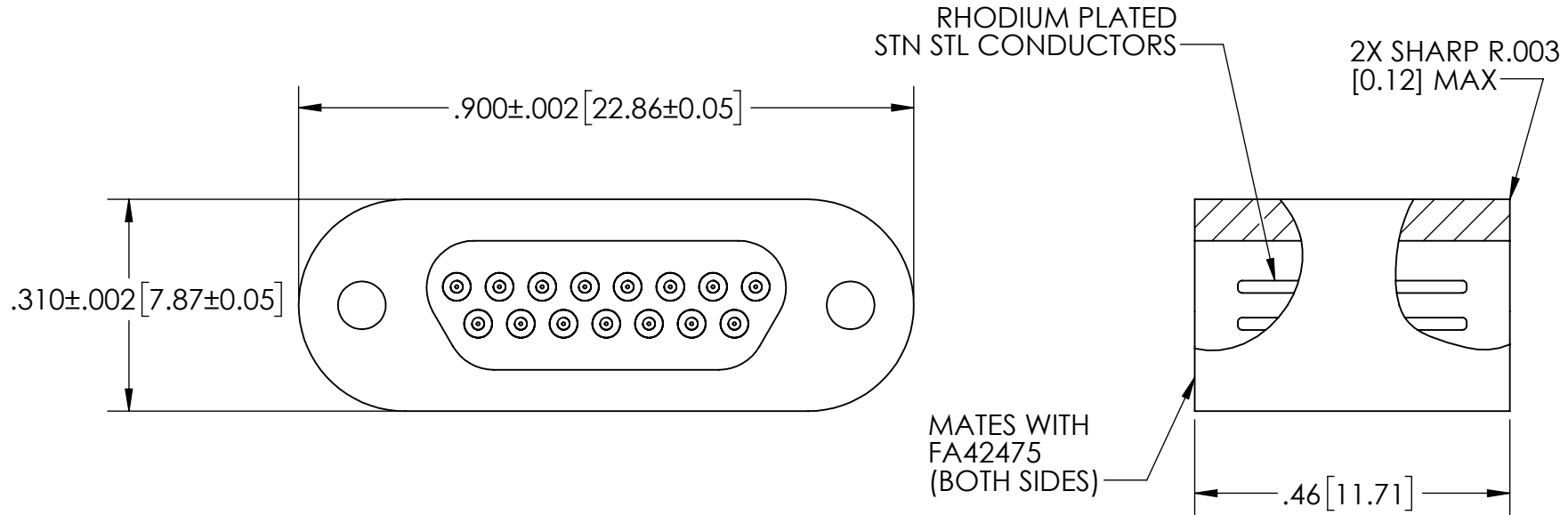

SCALE 1:1

**PLUGS & CONTACTS SOLD SEPARATELY**

- AIR / VACUUM SIDE PLUG (WITHOUT CONTACTS): FA42475
- GOLD PLATED BRASS/BeCu CRIMP CONTACTS: KT41236
- GOLD PLATED TeCu/BeNi CRIMP CONTACTS: KT41236-02

PERFORMANCE SPECIFICATIONS	
VOLTAGE (DWV):	250V DC
CURRENT	2.3 AMPS*
TEMPERATURE:	-269°C TO 450°C

\*CURRENT FOR A SINGLE PIN (60°C HEAT RISE). DE-RATING MAY BE REQUIRED WHEN RUNNING MULTIPLE CONTACTS AT FULL CURRENT.

LEAK RATE < 1 X 10E-10 ATM-CC/SEC (He)

PROPRIETARY AND CONFIDENTIAL THE INFORMATION CONTAINED IN THIS DRAWING IS THE SOLE PROPERTY OF SOLID SEALING TECHNOLOGY. ANY REPRODUCTION IN PART OR AS A WHOLE WITHOUT THE WRITTEN PERMISSION OF SOLID SEALING TECHNOLOGY IS PROHIBITED.				THIRD ANGLE PROJECTION 		TITLE MICRO D+, 15 PIN			
REV.	APP'D	DATE	SCALE 4:1	DIMENSIONS IN INCHES [mm]	DRAWN	CW	4/21/2021	PART NO. FA42273 REV. A WWW.SOLIDSEALING.COM	
A2	HJ	07/19/2021	MPC10716-11	ENG APPR.	JF	05/07/2021	SALES DWG NO. FA42273SL REV. A2		

**DIMENSIONS ARE FOR REFERENCE ONLY. UNLESS NOTED, NO TOLERANCES ARE IMPLIED. CONSULT SST TO DISCUSS YOUR SPECIFIC REQUIREMENTS.**

### 3 PINS

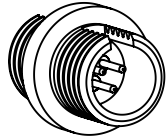

HERMETIC FEEDTHRU  
FA42916  
(LASER WELD ONLY)

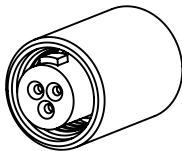

PLUG  
FA42930\*

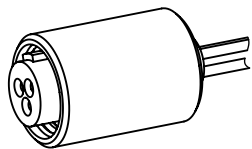

PRE-WIRED PLUG  
-KAPTON: FA43039  
-PTFE: FA43040

### 7 PINS

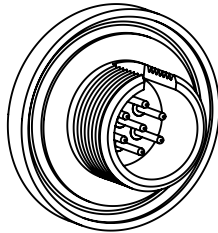

HERMETIC FEEDTHRU  
FA41283

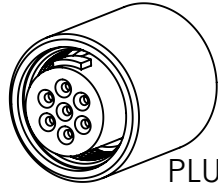

PLUG  
FA41289\*

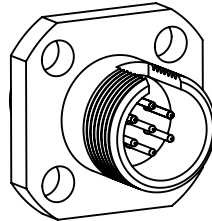

IN-VAC RECEPTACLE  
FA42367

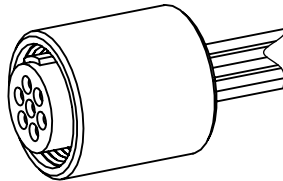

PRE-WIRED PLUG  
-KAPTON: FA42314  
-PTFE: FA42315

### 19 PINS

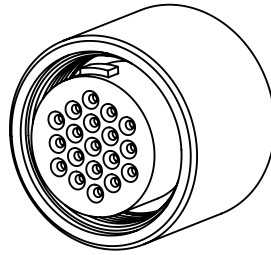

PLUG  
FA41232\*

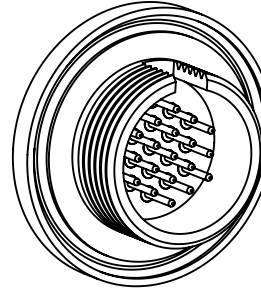

HERMETIC FEEDTHRU  
FA41401

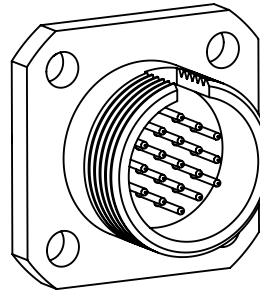

IN-VAC RECEPTACLE  
FA41656

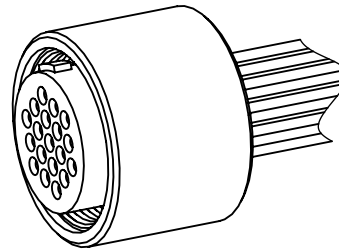

PRE-WIRED PLUG  
-KAPTON: FA42316  
-PTFE: FA42317

### 55 PINS

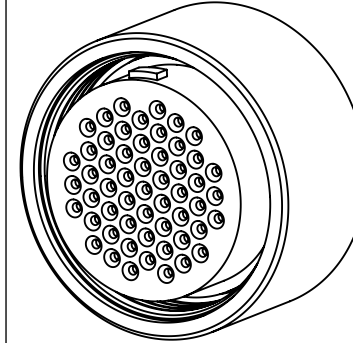

PLUG  
FA42256\*

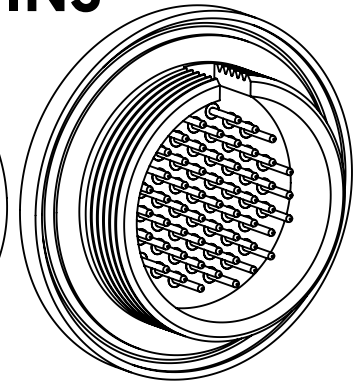

HERMETIC FEEDTHRU  
FA42250

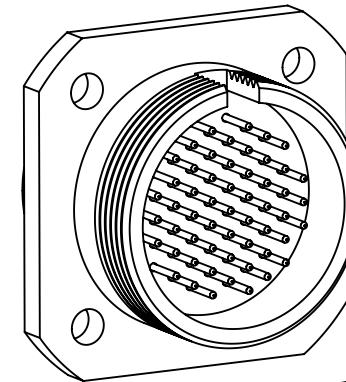

IN-VAC RECEPTACLE  
FA42375

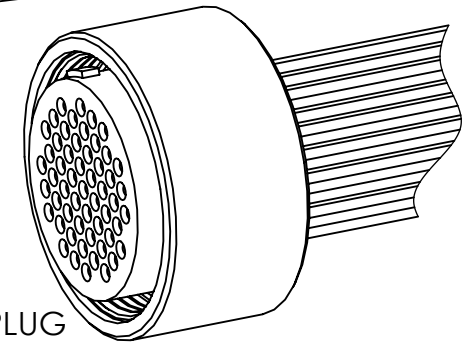

PRE-WIRED PLUG  
-KAPTON: FA42318  
-PTFE: FA42319

**\*CONTACTS NOT INCLUDED**

PROPRIETARY AND CONFIDENTIAL

THE INFORMATION CONTAINED IN THIS DRAWING IS THE SOLE PROPERTY OF SOLID SEALING TECHNOLOGY. ANY REPRODUCTION IN PART OR AS A WHOLE WITHOUT THE WRITTEN PERMISSION OF SOLID SEALING TECHNOLOGY IS PROHIBITED.

THIRD ANGLE PROJECTION

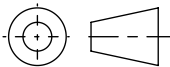

TITLE

MICRO SERIES FAMILY



**SOLID SEALING TECHNOLOGY**

REV.	APP'D	DATE	SCALE 2:1	DIMENSIONS IN INCHES [mm]	DRAWN	HJ	04/09/2021
A2	CW	4/21/2022	MPC10735-11		ENG APPR.	HJ	05/03/2021

REV: A2

WWW.SOLIDSEALING.COM

SALES DWG NO. MICRO\_SERIES REV. A2

***DIMENSIONS ARE FOR REFERENCE ONLY. UNLESS NOTED, NO TOLERANCES ARE IMPLIED. CONSULT SST TO DISCUSS YOUR SPECIFIC REQUIREMENTS.***

# 9 PINS

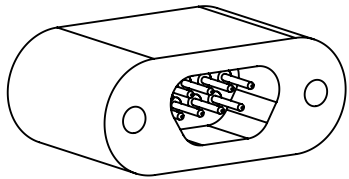

HERMETIC FEEDTHROUGH FA41500

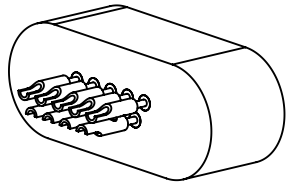

HERMETIC SOLDERCUP FEEDTHROUGH FA42164

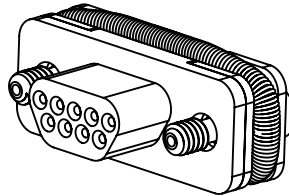

PLUG, GARTER TYPE FA42137

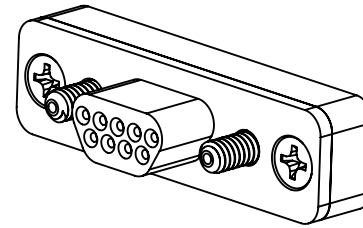

PLUG, SCREW TYPE: FA41506

PRE-WIRED PLUG  
-KAPTON: FA42239  
-PTFE: FA42419

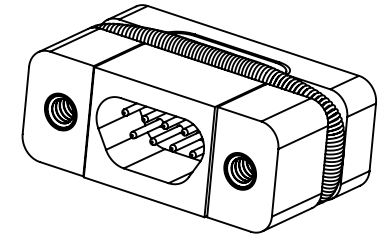

IN-VAC RECEPTACLE FA42394

# 15 PINS

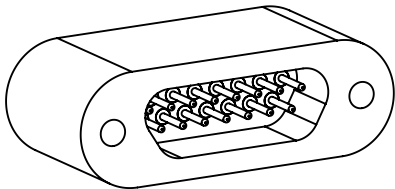

HERMETIC FEEDTHROUGH FA42273

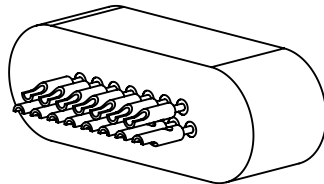

HERMETIC SOLDERCUP FEEDTHROUGH FA42467

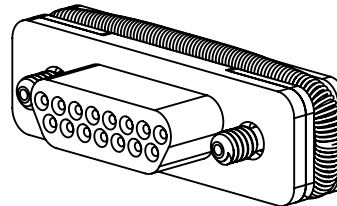

PLUG, GARTER TYPE FA42475

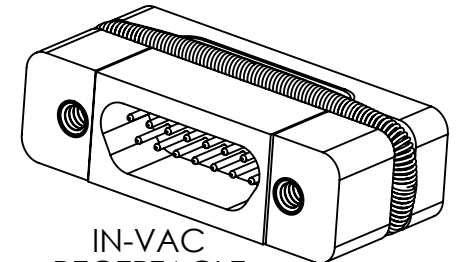

IN-VAC RECEPTACLE FA42488

# CONTACTS/WIRE

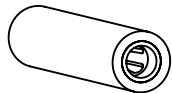

SOCKET CONTACTS  
KT41236 (BRASS 125C)  
KT41236-02 (TeCu 250C)

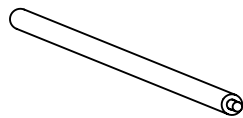

WIRE  
KAPTON 48": FA42244  
KAPTON 96": FA42245  
PTFE 48": FA42246-01/09  
PTFE 96": FA42247-01/09



CRIMP TOOL POSITIONER (PIN & SOCKET) FP41731

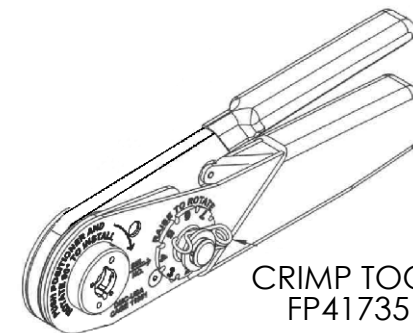

CRIMP TOOL FP41735

PROPRIETARY AND CONFIDENTIAL

THE INFORMATION CONTAINED IN THIS DRAWING IS THE SOLE PROPERTY OF SOLID SEALING TECHNOLOGY. ANY REPRODUCTION IN PART OR AS A WHOLE WITHOUT THE WRITTEN PERMISSION OF SOLID SEALING TECHNOLOGY IS PROHIBITED.

THIRD ANGLE PROJECTION

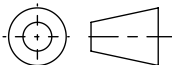

TITLE

MICRO SERIES FAMILY



**SOLID SEALING**  
TECHNOLOGY

REV.	APP'D	DATE	SCALE 2:1	DIMENSIONS IN INCHES [mm]	DRAWN	HJ	04/09/2021
A2	CW	4/21/2022	AHDWR027-41		ENG APPR.	HJ	05/03/2021

REV. A2

WWW.SOLIDSEALING.COM

SALES DWG NO. MICRO\_SERIES REV. A2

**DIMENSIONS ARE FOR REFERENCE ONLY. UNLESS NOTED, NO TOLERANCES ARE IMPLIED. CONSULT SST TO DISCUSS YOUR SPECIFIC REQUIREMENTS.**