

PART NO.	CABLE LENGTH
FA42314	48"
FA42314-02	96"

PERFORMANCE SPECIFICATIONS	
VOLTAGE:	250V DC
CURRENT:	3 AMPS
TEMPERATURE:	-55°C TO 200°C

PROPRIETARY AND CONFIDENTIAL THE INFORMATION CONTAINED IN THIS DRAWING IS THE SOLE PROPERTY OF SOLID SEALING TECHNOLOGY. ANY REPRODUCTION IN PART OR AS A WHOLE WITHOUT THE WRITTEN PERMISSION OF SOLID SEALING TECHNOLOGY IS PROHIBITED.				THIRD ANGLE PROJECTION 		TITLE <b>MICRO C, 7 PIN VACUUM PLUG CABLE ASSEMBLY</b>			
REV.	APP'D	DATE	SCALE 3:1	DIMENSIONS IN INCHES [mm]	DRAWN	CW	4/15/2021	PART NO. (SEE TABLE) REV. A	WWW.SOLIDSEALING.COM
A1	JF	04/20/2021	MSMM0128-11	ENG APPR.	JF	04/20/2021			SALES DWG NO. FA42314SL REV. A1

**DIMENSIONS ARE FOR REFERENCE ONLY. UNLESS NOTED, NO TOLERANCES ARE IMPLIED. CONSULT SST TO DISCUSS YOUR SPECIFIC REQUIREMENTS.**

# 7 PINS

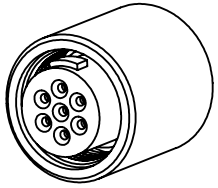

PLUG  
FA41289

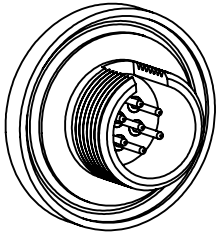

HERMETIC  
FEEDTHRU  
FA41283

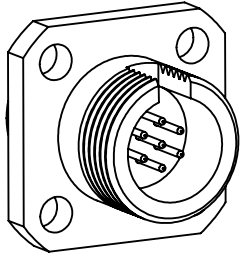

IN-VAC  
RECEPTACLE  
FA42367

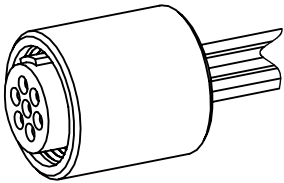

PRE-WIRED PLUG  
-KAPTON: FA42314  
-PTFE: FA42315

# 19 PINS

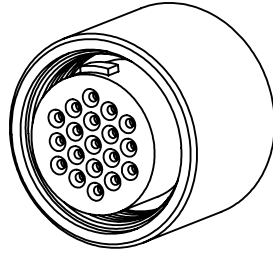

PLUG  
FA41232

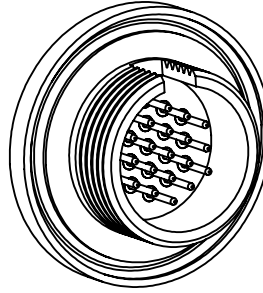

HERMETIC  
FEEDTHRU  
FA41401

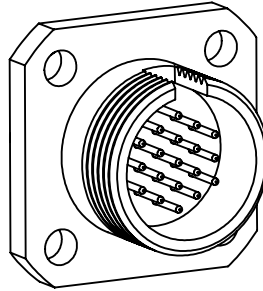

IN-VAC  
RECEPTACLE  
FA41656

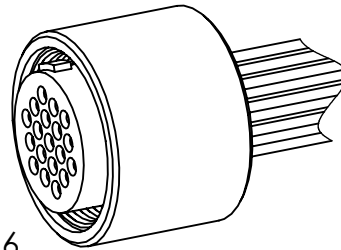

PRE-WIRED PLUG  
-KAPTON: FA42316  
-PTFE: FA42317

# 55 PINS

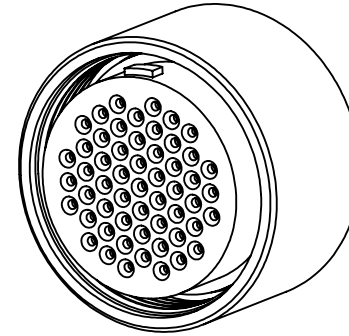

PLUG  
FA42256

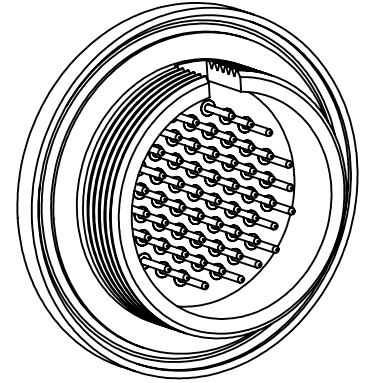

HERMETIC FEEDTHRU  
FA42250

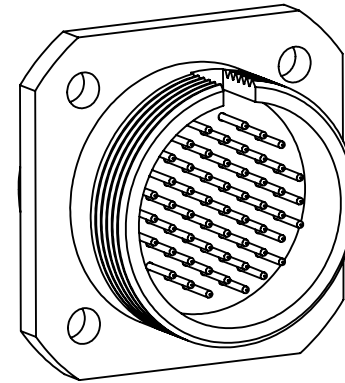

IN-VAC  
RECEPTACLE  
FA42375

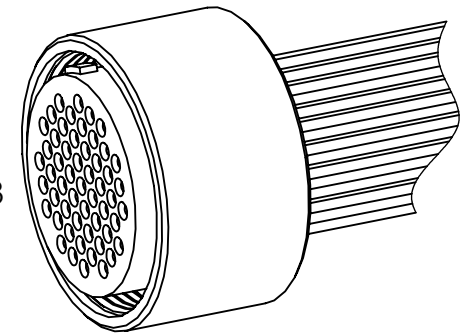

PRE-WIRED PLUG  
-KAPTON: FA42318  
-PTFE: FA42319

PROPRIETARY AND CONFIDENTIAL

THE INFORMATION CONTAINED IN THIS DRAWING IS THE SOLE PROPERTY OF SOLID SEALING TECHNOLOGY. ANY REPRODUCTION IN PART OR AS A WHOLE WITHOUT THE WRITTEN PERMISSION OF SOLID SEALING TECHNOLOGY IS PROHIBITED.

THIRD ANGLE  
PROJECTION

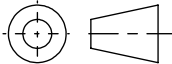

TITLE

MICRO SERIES FAMILY



REV.	APP'D	DATE	SCALE 2:1	DIMENSIONS IN INCHES [mm]	DRAWN	HJ	04/09/2021
A1	HJ	05/03/2021	MPC10703-07		ENG APPR.	HJ	05/03/2021

REV: A1

WWW.SOLIDSEALING.COM

SALES DWG NO. MICRO\_SERIES REV. A1

***DIMENSIONS ARE FOR REFERENCE ONLY. UNLESS NOTED, NO TOLERANCES ARE IMPLIED. CONSULT SST TO DISCUSS YOUR SPECIFIC REQUIREMENTS.***

# 9 PINS

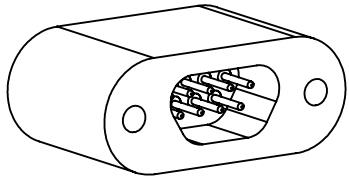

HERMETIC FEEDTHROUGH FA41500

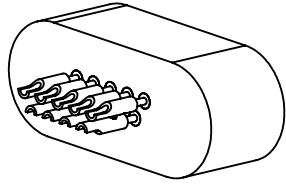

HERMETIC SOLDERCUP FEEDTHROUGH FA42164

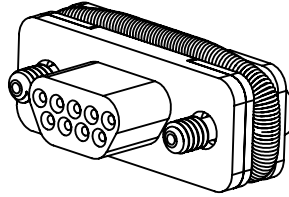

PLUG, GARTER TYPE FA42137

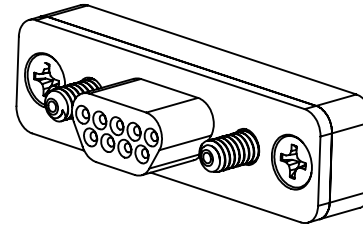

PLUG, SCREW TYPE: FA41506  
PRE-WIRED PLUG  
-KAPTON: FA42239  
-PTFE: FA42419

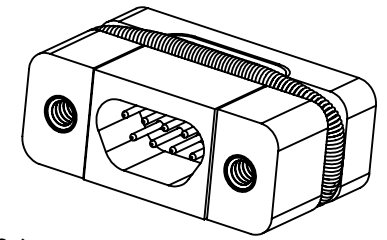

IN-VAC RECEPTACLE FA42394

# 15 PINS

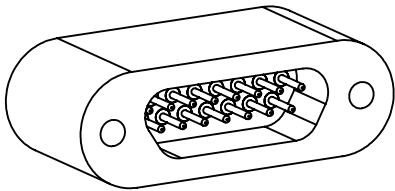

HERMETIC FEEDTHROUGH FA42273

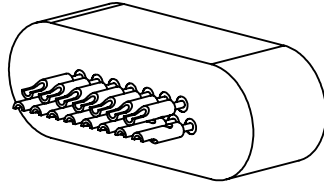

HERMETIC SOLDERCUP FEEDTHROUGH FA42467

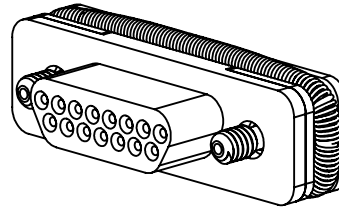

PLUG, GARTER TYPE FA42475

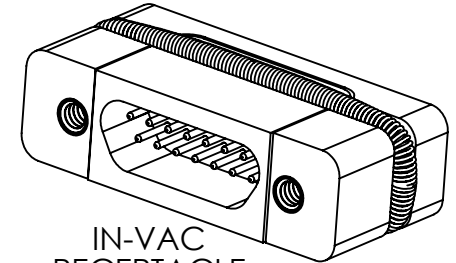

IN-VAC RECEPTACLE FA42488

# CONTACTS/WIRE

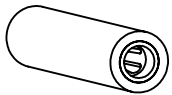

SOCKET CONTACTS  
KT41236 (BRASS 125C)  
KT41236-02 (TeCu 250C)

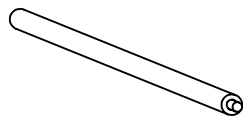

WIRE  
KAPTON 48": FA42244  
KAPTON 96": FA42245  
PTFE 48": FA42246-01/09  
PTFE 96": FA42247-01/09



CRIMP TOOL POSITIONER (PIN & SOCKET) FP41731

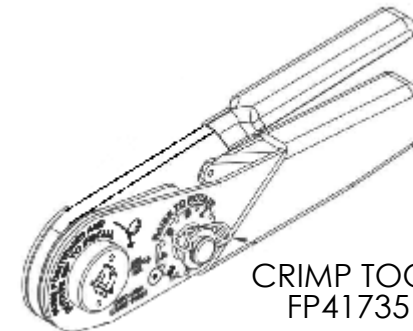

CRIMP TOOL FP41735

PROPRIETARY AND CONFIDENTIAL

THE INFORMATION CONTAINED IN THIS DRAWING IS THE SOLE PROPERTY OF SOLID SEALING TECHNOLOGY. ANY REPRODUCTION IN PART OR AS A WHOLE WITHOUT THE WRITTEN PERMISSION OF SOLID SEALING TECHNOLOGY IS PROHIBITED.

THIRD ANGLE PROJECTION

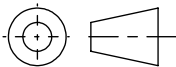

TITLE

MICRO SERIES FAMILY



REV.	APP'D	DATE	SCALE 2:1	DIMENSIONS IN INCHES [mm]	DRAWN	HJ	04/09/2021
A1	HJ	05/03/2021	AHDWR027-41		ENG APPR.	HJ	05/03/2021

REV. A1

WWW.SOLIDSEALING.COM

SALES DWG NO. MICRO\_SERIES REV. A1

**DIMENSIONS ARE FOR REFERENCE ONLY. UNLESS NOTED, NO TOLERANCES ARE IMPLIED. CONSULT SST TO DISCUSS YOUR SPECIFIC REQUIREMENTS.**